

PHY-P-200

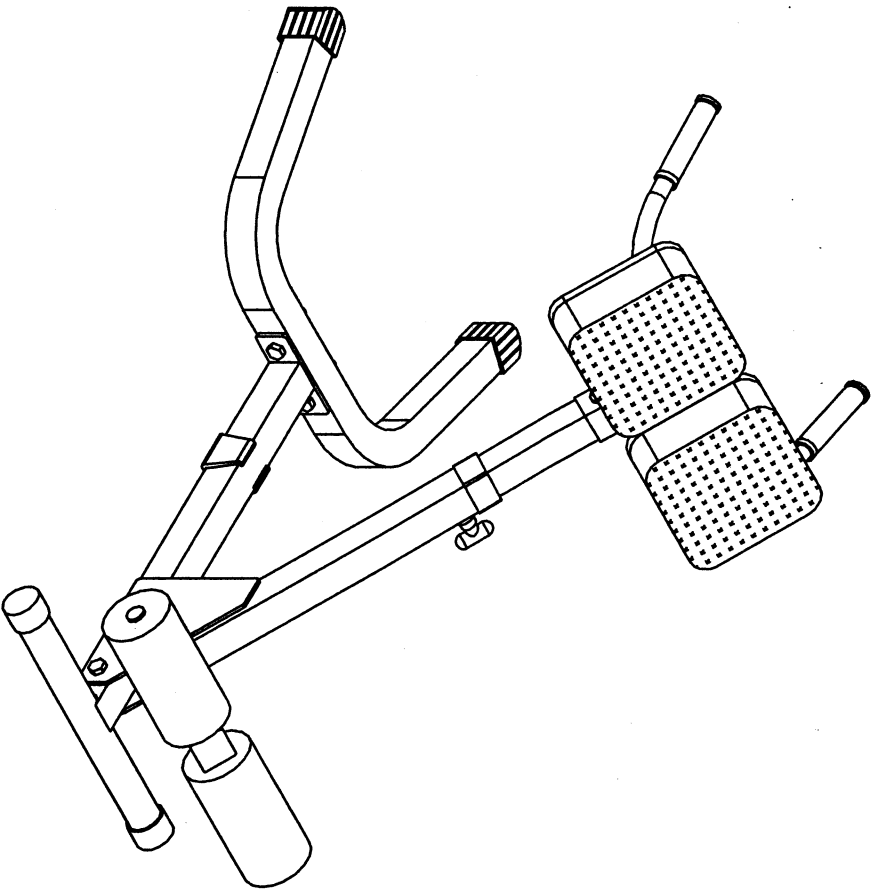

















VERSION 0506

# PHYYP-200 HARDWARE ILLUSTRATION SHEET

A1. M12X75 HEX HEAD BOLT	_____	[2PCS]
A2. M12X70 HEX HEAD BOLT	_____	[2PCS]
A3. M12X65 HEX HEAD BOLT	_____	[2PCS]
A4. 5/16X1 3/4" HEX HEAD BOLT	_____	[4PCS]
B1 M12 NYLON LOCK NUT	_____	[6PCS]
C1 M12 (I.D.)WASHER	_____	[6PCS]
C2. 5/16" (I.D.)WASHER	_____	[4PCS]
C3. 5/16" SPRING WASHER	_____	[4PCS]
D1. ø50 ROUND FOOT CAP (9212-008)	_____	[2PCS]
D2. ø1" ROUND END CAP (9211-016)	_____	[2PCS]
D3. 2"X1 3/4" NYLON BUSHING (9211-030)	_____	[1PCS]
D4. 2"X2" END CAP (9211-005)	_____	[1PCS]
D5. 1 3/4"X1 3/4" END CAP (9211-004)	_____	[1PCS]
D6. 1"X2" END CAP (9211-009)	_____	[2PCS]
D7. RUBBER GRIP (9212-016)	_____	[2PCS]
D8. 2"X2" FOOT CAP (9212-003)	_____	[2PCS]
D10. 2"X2" RUBBER DONUT (9212-010)	_____	[1PCS]
D11. 3"X23X8" FOAM ROLLER (9161-029A)	_____	[2PCS]

Qty.

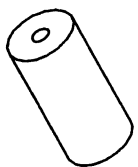
A1		A2		A3		A4		B1	
C1		C2		C3		D1		D2	
D3		D4		D5		D6		D7	
D8		D10		D11					

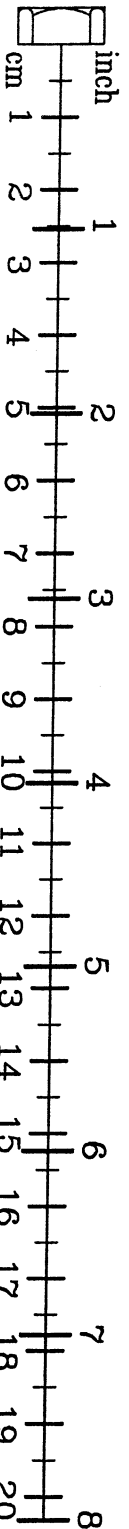

# PHYYP-200 PARTS ILLUSTRATION SHEET

A [1PCS]

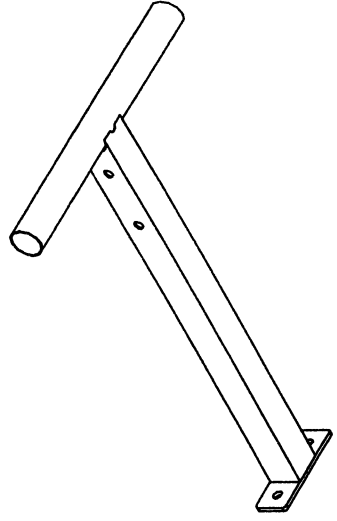

B [1PCS]

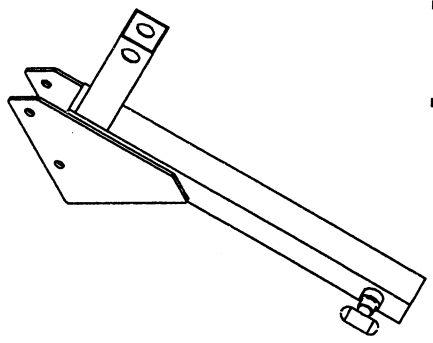

C [1PCS]

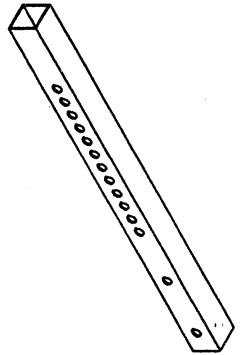

D [1PCS]

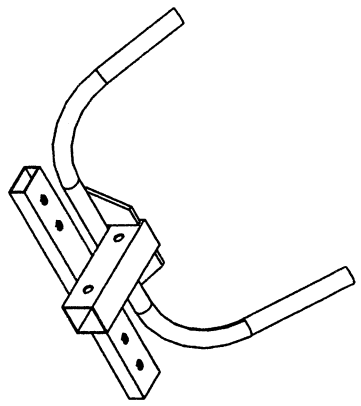

E [1PCS]

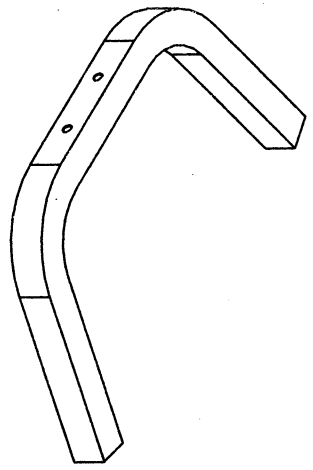

F [1PCS]

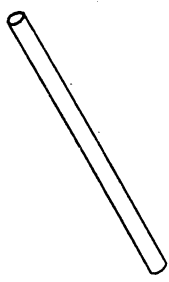

G [1PCS] Left  
9132-009

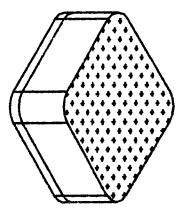

H [1PCS] Right  
9132-010

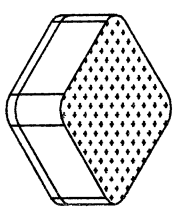

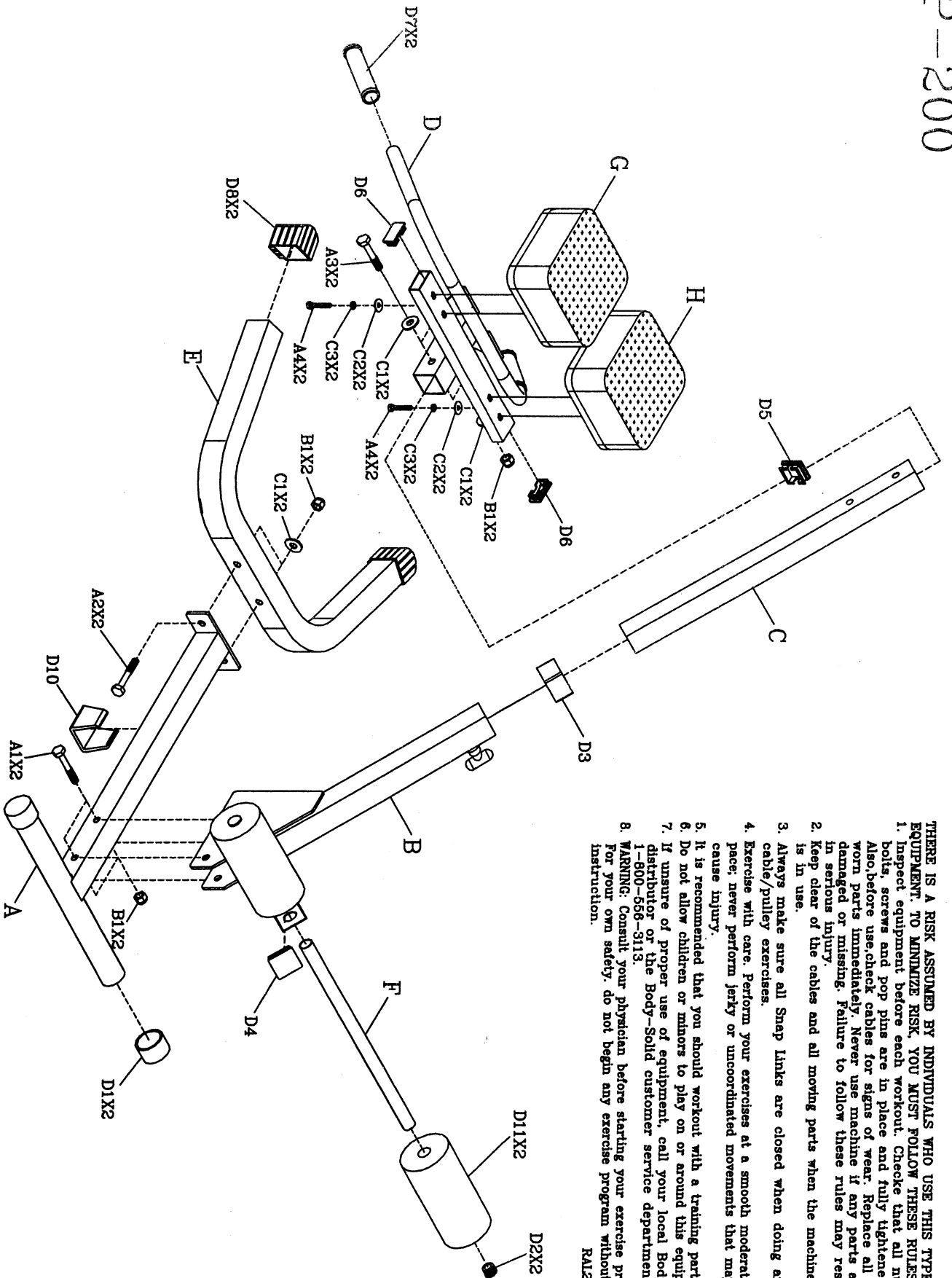

**THERE IS A RISK ASSUMED BY INDIVIDUALS WHO USE THIS TYPE OF EQUIPMENT. TO MINIMIZE RISK, YOU MUST FOLLOW THESE RULES:**

1. Inspect equipment before each workout. Check that all nuts, bolts, screws and pop pins are in place and fully tightened. Also, before use, check cables for signs of wear. Replace all worn parts immediately. Never use machine if any parts are damaged or missing. Failure to follow these rules may result in serious injury.
2. Keep clear of the cables and all moving parts when the machine is in use.
3. Always make sure all Snap Links are closed when doing any cable/pulley exercises.
4. Exercise with care. Perform your exercises at a smooth moderate pace, never perform jerky or uncoordinated movements that may cause injury.
5. It is recommended that you should workout with a training partner.
6. Do not allow children or minors to play on or around this equipment.
7. If unsure of proper use of equipment, call your local Body-Solid distributor or the Body-Solid customer service department at 1-800-556-3113.
8. **WARNING:** Consult your physician before starting your exercise program. For your own safety, do not begin any exercise program without proper instruction.

RA12-11-98