

Body-Solid®

Built for Life

K N O W Y O U R G Y M

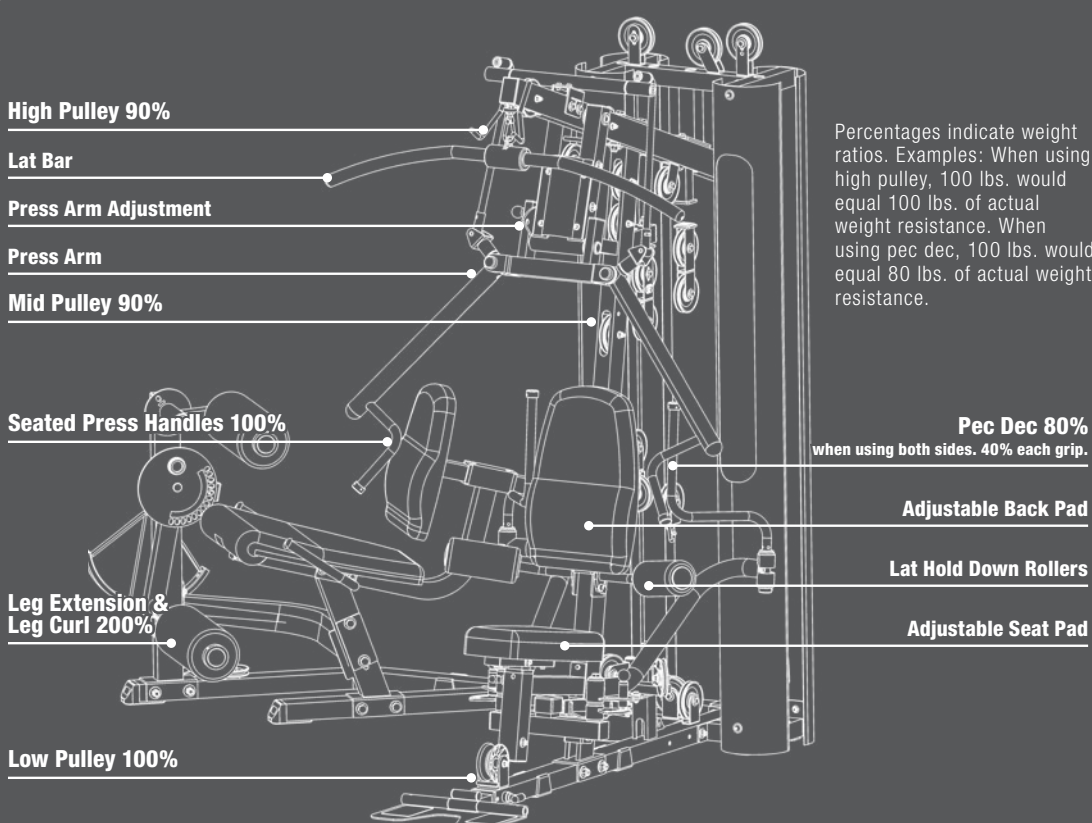

T R A I N I N G T I P S

SAMPLE EXERCISE PROGRAMS

- Exercise your complete body every other day, up to three times a week. The one day rest enables your body to recover from the previous workout.
- Alternate your daily workouts. One day isolate the upper body exercises, and the next day perform the lower body exercises.

It is important to first establish specific and realistic goals. You should determine your long term goal and then set a series of short term goals that will help you attain your long term goal. For maximum results, follow a complete fitness program that includes proper nutrition, aerobic exercise and strength training.

SAMPLE TRAINING METHODS

- FOR MUSCULAR ENDURANCE & DEFINITION:** This training method incorporates achieving and maintaining a high cardiovascular (heart) rate and helps burn away excess fatty tissue. It also adds muscle definition and muscular endurance to your entire body. Exercises are most commonly performed for 15 to 20 repetitions and 3 to 4 sets using a light to moderate weight. The rest period between sets should be about 30 seconds. These short rest intervals will help maintain an elevated heart rate and prevent the muscles from cooling down.
- FOR STRENGTH:** This type of training is the most popular of the three and is designed specifically for increasing strength throughout the muscle and the muscle-tendon junction. This type of training is especially important for athletes. Normally, exercises are performed using moderate to heavy weight for 8 to 12 repetition and 2 to 3 sets. The rest period between sets should be from 60 to 90 seconds. This allows a degree of muscle recovery before you hit them again.
- FOR POWER & MUSCLE MASS:** This is the method most often used by bodybuilders and is recommended only for the intermediate and advanced lifter. The weights used are heavy – this shocks the muscles and stimulates a more rapid increase in muscle size. Usually exercises are performed for 2 to 6 repetitions and 3 to 4 sets using very heavy weight. The rest period between sets should be 3 to 4 minutes. The prolonged rest periods allow ample time for recovery between sets.

*A **repetition** is defined as one complete movement from the starting position, through the full range of motion, and back to the starting position. A **set** is defined as a series of continuous repetitions. Start your exercise program conservatively. Select a weight for each exercise that is easily performed for the full range of motion. Learn to feel your body's responses and change your program and training method accordingly. See Owner's Manual for more information.*

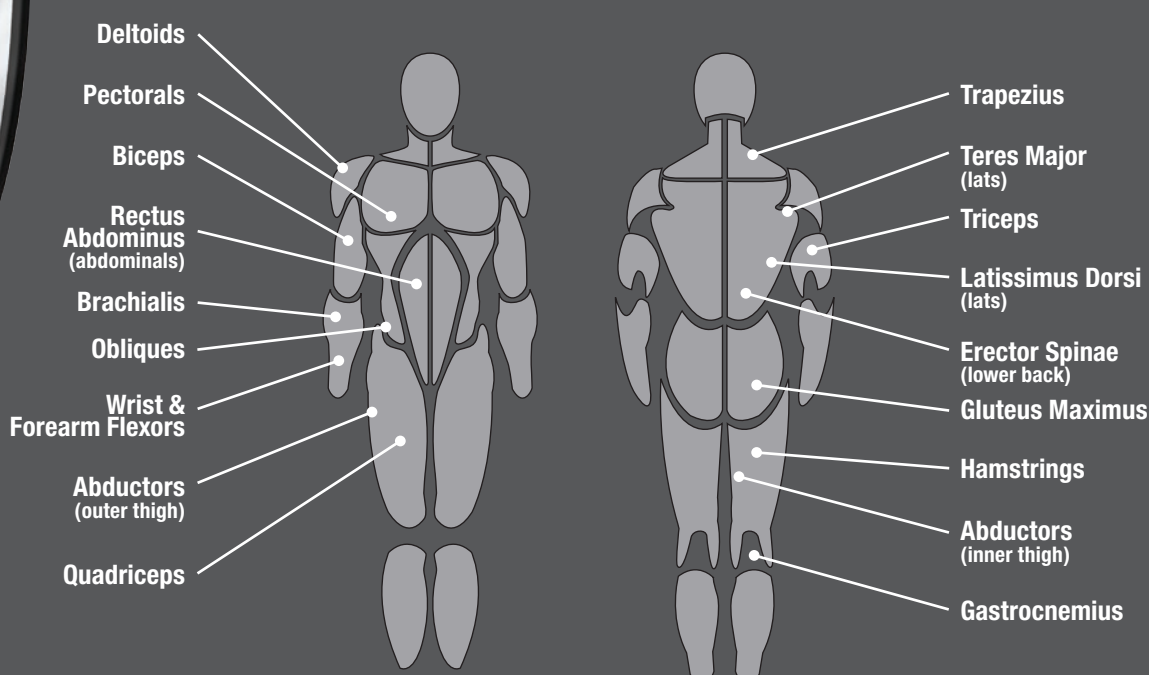

S A F E T Y P R E C A U T I O N S

EXERCISE SAFETY

Consult your physician before beginning any exercise program.

Always warm up your muscles before starting a workout by doing at least 5 to 15 minutes of cardiovascular exercise. Then do an 8 to 12 minute stretching routine. Stretch slowly (without bouncing) and hold each stretch for at least 10 seconds. The two main purposes for stretching are injury prevention and a faster rate of recovery from exercise. Stretching should be performed in both the warm up and cool down phases of a training program.

Use proper form. Maintain proper spinal alignment and head positioning throughout your workout. Focus on only working the muscle group intended for the exercise you are doing. If there is strain elsewhere, you may need to re-evaluate the amount of weight that is involved with the lift. Keeping proper form also includes maintaining control through the entire range of motion.

Breath properly. Exhale during the pressing action and inhale upon returning to the start position. Do not hold your breath during any part of an exercise.

Be sure that all users carefully read and understand all warning, safety and maintenance labels on the machine before each use. It is absolutely necessary that you familiarize yourself and all others with the proper operation of this machine prior to use.

Avoid the risk of injury by remaining within your limits.

EQUIPMENT SAFETY

- Make sure that all users read and understand the Owner's Manual, all warning labels and all decals on this machine prior to use. Please use all precautionary measures necessary for safety.
- Keep observers (especially children) at a safe distance away from the machine while in operation. Do not allow children to play on or around the machine at any time.
- Carefully inspect the machine before each use. Check that all nuts, bolts, pop pins and adjustment points are in place and fully tightened. Replace worn parts immediately.
- Cable inspection should be performed daily. Cables are wear items. It is your responsibility to prevent unexpected breakage. Replace any damaged or worn cable immediately. Do not allow the machine to be used until damaged or worn cables are replaced. Using a machine with a suspect cable can result in serious injury. See Owner's Manual for more information.
- Always stay clear of all weights and all moving parts when machine is in use. Obtain assistance to free any jammed parts. Never attempt to free a jammed part by yourself.
- Maintain a regular routine of preventative maintenance.
- For your own safety, do not begin any exercise program without proper instruction.

See Owner's Manual for more information.

www.bodysolid.com

EXERCISE CHART

CHEST

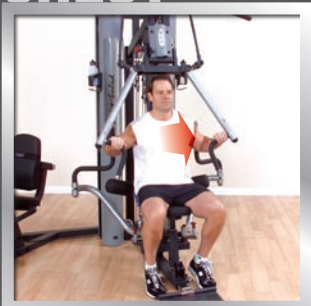

Horizontal Grip Chest Press



Incline Press



Pectoral Fly

SHOULDERS

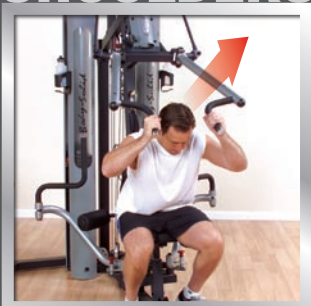

Shoulder Press



Upright Row



Front Deltoid Raise

BACK

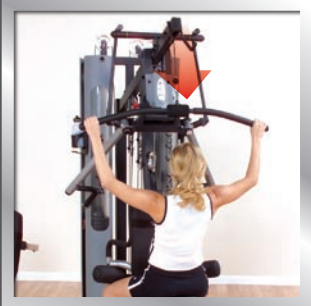

Lat Pull Down



Bent Over Row



Seated Row

ARMS



Biceps Curl



Triceps Press Down



Triceps Extension

ABS



Resistance Ab Crunch



Oblique Crunch

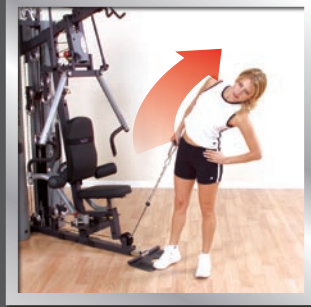

Oblique Bend

HIPS/THIGHS

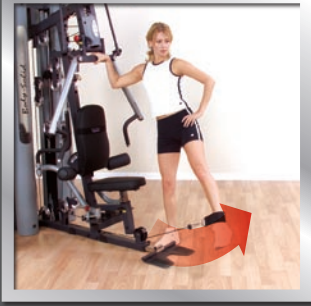

Leg Abduction

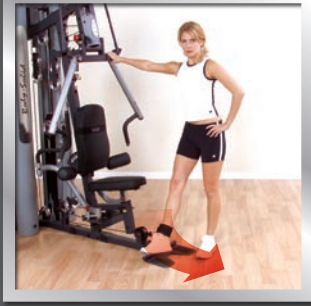

Leg Adduction



Leg Press

LEGS



Leg Extension



Leg Curl



Calf Press

Perform over 40 exercises on the Body Solid® G10B Bi-Angular® Home Gym. For more information on exercises see your owners manual, the Total Body Workout DVD, or visit our website.



FREE TOTAL BODY WORKOUT DVD WITH GYM PURCHASE!

